



motorola

Digital Cordless Telephone



Motorola T1

Models: T101, T102, T103 and T104



Warning: Charge the handset for 24 hours before use.

Welcome...

to your new Motorola T1 Digital Cordless Telephone!

- All handsets are fully cordless for locating anywhere within range.
- 50 Name and Number phonebook.
- Bright backlit display.
- Speakerphone for hands-free conversations.
- Caller ID shows you who's calling and see details of the last 20 callers in a Calls list.¹
- Redial up to 10 of the last numbers called.
- Register up to 4 handsets to a single base.
- Make internal calls and transfer external calls between handsets.

Please note that this equipment is not designed for making emergency telephone calls when the power fails. Alternative arrangements should be made for access to emergency services.

Need help?

If you have any problems setting up or using your T1, please contact Customer Services on XXXX XXXXXXXX.

Alternatively, you may find the answer in the 'Help' section at the back of this guide.

¹You must subscribe to your network provider's Caller ID or Call Waiting service for these features to work. A subscription fee may be payable.

This user guide provides you with all the information you need to get the most from your phone.

To set up your phone, follow the simple instructions in ‘Getting Started’, on the next few pages.

IMPORTANT

Only use the telephone line cord supplied.

Got everything?

- T1 base & cordless handset
- 2 x rechargeable Ni-MH battery cells
- Power adaptor for the base
- Telephone line cord

If you have purchased a T1 multiple pack you will also have the following additional items:

- Cordless handset & charger
- 2 x rechargeable Ni-MH battery cells
- Power adaptor for the charger



ecomoto™

ECOMOTO: a convergence of efforts by marketing, design, research, engineering and supply chain management that leads to better products for everyone. A holistic view that focuses on both social and environmental responsibility. A passion and a shared point of view.

The right thing to do.

- Meets and / or exceeds EMEA environmental regulatory requirements.
- Eco friendly packaging with a minimum 20% post consumer recycled content.
- Phone housing is built with a minimum of 25% post consumer recycled content plastic.
- Energy efficient charger that meets EU Code of Conduct requirements.
- ECO mode function which reduces the transmitted power and energy consumption, see page 26.

1.	Getting started	6
2.	Getting to know your phone	10
3.	Using the phone	15
3.1	Switch the handset on / off	15
3.2	Calls	15
3.2.1	Make a call.....	15
3.2.2	Preparatory dialling.....	15
3.2.3	End a call	15
3.2.4	Receive a call	15
3.3	Adjust the earpiece volume.....	15
3.4	Mute	15
3.5	Intercom.....	15
3.5.1	Make an internal call	15
3.5.2	Receive an internal call	16
3.5.3	Transfer a call	16
3.5.4	3-way conference call	16
3.6	Hands-free.....	16
3.6.1	Make a hands-free call	16
3.6.2	Answer a call hands-free	17
3.6.3	Switch to hands-free during a call.	17
3.7	Redial	17
3.7.1	View or dial an entry.....	17
3.7.2	Copy a Redial list number to the phonebook.....	17
3.7.3	Delete an entry.....	17
3.7.4	Delete the entire Redial list.....	18
3.8	Lock / unlock the keypad	18
3.9	Paging / Find handset	18
4.	Phonebook	19
4.1	Store a name and number	19
4.2	View or dial an entry.....	20
4.3	Edit a name and number	20
4.4	Delete an entry	20
4.5	Delete all entries	20
5.	Caller ID and the Calls list	21
5.1	Caller ID	21
5.2	Calls list	21
5.2.1	View the Calls list.....	21
5.2.2	Dial a number in the Calls list	21
5.2.3	Copy a Calls list number to the phonebook	22
5.2.4	Delete an entry.....	22
5.2.5	Delete the entire Calls list.....	22

6.	Clock & alarm	23
6.1	Set the date and time.....	23
6.2	Set the alarm	23
6.3	Switch off alarm ring	23
7.	Personal settings.....	24
7.1	Handset tones.....	24
7.1.1	Handset ringer volume	24
7.1.2	Handset ringer melody.....	24
7.1.3	Key beep	24
7.2	Handset name.....	24
7.3	Auto answer	25
7.5	Language	25
8.	Base settings	26
8.1	ECO mode	26
8.2	ECO PLUS	26
8.3	Auto Prefix.....	26
8.4	Recall mode.....	27
8.5	Dial mode.....	27
8.6	Change base PIN code	27
8.7	Registering an additional handset.....	27
8.8	De-register a handset	28
8.9	Restore default settings	28
8.10	Default settings	29
9.	Help.....	30
10.	General information	32

1. Getting started

IMPORTANT

Do not place your T1 in the bathroom or other humid areas.

Location



You need to place your T1 base within 1.5 metres of the mains power and telephone wall socket so that the cables will reach. The socket-outlet should be installed near the equipment and should be easily accessible.

Make sure that it is at least 1 metre away from other electrical appliances to avoid interference. Your T1 works by sending radio signals between the handset and base. The strength of the signal depends on where you place the base. Placing it as high as possible ensures the best signal.

HANDSET RANGE

The unit has a range of up to 300 metres outdoors when there is a clear line of sight between the base and handset. Any obstruction between the base and handset will reduce the range significantly. With the base indoors and the handset either indoors or outdoors, the range will normally be up to 50 metres. Thick concrete and stone walls can severely affect the range.

SIGNAL STRENGTH

The  icon on your handset indicates that you are within range of the base. When out of range of the base, the  icon flashes. If you are on a call, you will hear a warning beep.

The line will hang up if the handset moves out of range of the base. Move closer to the base. The handset will automatically reconnect to the base.



Setting up

IMPORTANT

The base station must be plugged into the mains power at all times. Do not connect the telephone line cord into the wall socket until the handset is fully charged. Use only the power adaptor and telephone line cord supplied with the product.

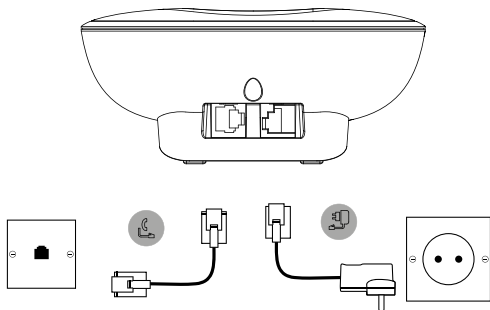
Connecting the base



1. Plug the telephone line cord into the socket marked  on the underside of the base.
2. Plug the power adaptor into the socket marked  on the underside of the base and plug the other end into the mains power wall socket. Switch on the mains power.

Installing and charging the handset

1. Remove the battery cover from the back of the handset and insert the rechargeable Ni-MH battery cells supplied. Please note the '+' and '-' markings inside the battery compartment and insert in the correct direction.

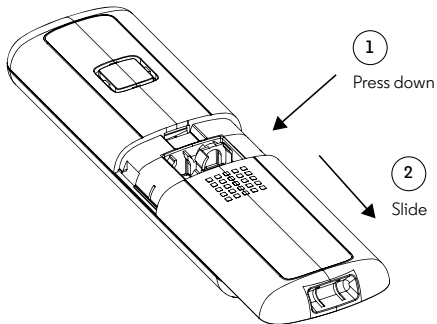



2. Slide the battery cover back into place.
3. If you are charging the batteries for the first time, place the handset on the base to charge for at least 24 hours continuously.

- When the handset is fully charged, the  icon will appear steady on the display. Plug the other end of the telephone line cord (make sure that one end is already plugged into the base) into the telephone wall socket.

Connecting the handset and charger (for multi-pack only)

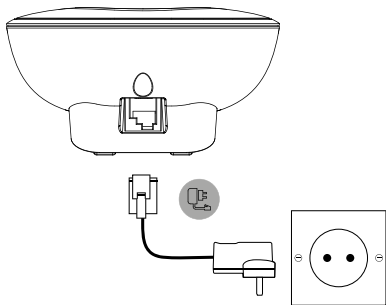
If you have purchased a multiple pack, you will need to carry out this process for all the handsets and chargers.



- Plug the power adaptor into the socket marked  on the underside of the charger and plug the other end into the mains power wall socket.
- Remove the battery cover from the back of the handset and insert the 2 x AAA NiMH rechargeable batteries supplied. Please note the '+' and '-' markings inside the battery compartment and insert in the correct direction.
- Slide the battery cover back into place.
- If you are charging the batteries for the first time, place the handset on the charger to charge for at least 24 hours continuously.
- When the handset is fully charged, the  icon will appear steady on the display. The display will show HANDSET and handset number (e.g. 2) to indicate that it is registered to the base.

IMPORTANT

Warning! Use only the approved rechargeable Ni-MH battery cells (2 x AAA Ni-MH 300mA rechargeable batteries) supplied with your T1.

BATTERY LOW WARNING

If the  icon flashes on the display and you hear a warning beep every minute during a call, you will need to recharge the handset before you can use it again.

When charging, the  icon will scroll on the display.

BATTERY PERFORMANCE

In ideal conditions, fully charged batteries should give up to 10 hours talk time or up to 200 hours standby time on a single charge.¹

Note that new batteries do not reach their full capacity until they have been put to normal use for several days.

To keep your batteries in the best condition, leave the handset off the base for a few hours at a time.







Running the batteries right down at least once a week will help them last as long as possible.

The charge capacity of rechargeable batteries will reduce with time as they wear out, giving the handset less talk / standby time. Eventually they will need to be replaced.

After charging your handset for the first time, subsequent charging time is about 6–8 hours a day. Batteries and handset may become warm during charging. This is normal.

¹All talk and standby times are approximate and depend on features selected and usage pattern.

Date and time

1. Press , scroll  to CLOCK/ALARM and press .
2. The display shows DATE & TIME.
3. Press  to select.
4. Enter the date using the keypad (e.g. 12-08-15 for 12th of August 2015) and press  to confirm.
5. Enter the time using the keypad (e.g. 06-30 for 6:30am) and press  to confirm.

Your T1 is now ready for use.

2. Getting to know your phone

Overview of your handset

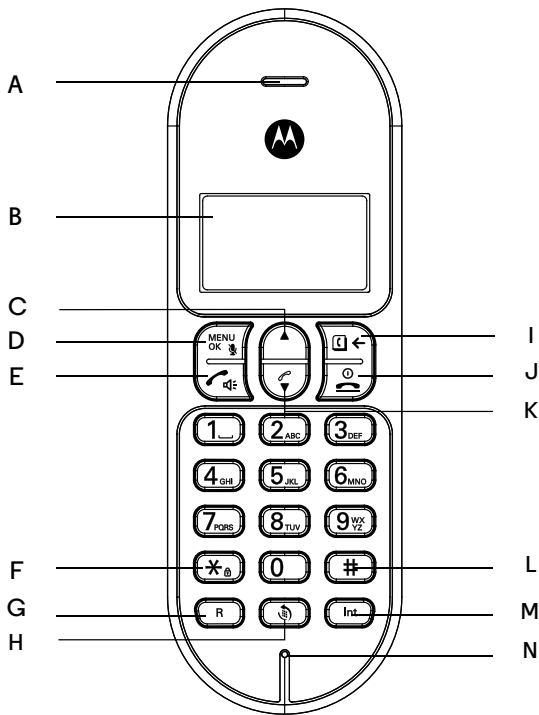

A Earpiece

B Display

See page 12 for an overview of the display icons.

C Up

During a call, press to increase earpiece volume.

When the phone is ringing, press to increase the handset ringer volume.

Press to scroll through the menu options, redial list, calls list and phonebook entries.

D Menu / OK / Mute

Press to open the Menu.

Press to select menu options and to confirm a displayed option.

During a call, press to turn mute on / off.

E Talk / Hands-free

Press to switch hands-free on or off during a call.

Press to make and receive calls.

F * / Keypad lock / Pulse to Tone dialling

Dial a *.

Press and hold to lock and unlock the keypad.

Press to switch from pulse dialling to tone dialling.

G Recall

Use with switchboard / PABX services and some network services.

H Redial

In standby mode, press to open the redial list.

I Phonebook / Delete / Back

In standby mode, press to open the phonebook menu.

In editing mode, press to delete characters and digits.

Go back to the previous menu level.

J End Call / Exit / Switch Handset on / off

Press to end a call.

When viewing the redial / calls list / phonebook or when in the menu, press to exit and return to standby.

Press and hold for 3 seconds to switch off the handset.

K Call list / Down

In standby mode, press to open the calls list.

During a call, press to decrease earpiece volume.

When the phone is ringing, press to decrease the handset ringer volume.

Press to scroll through the menu options, redial list, calls list and phonebook entries.

L Pause / #

Press and hold to enter a pause (P) when pre-dialling or storing numbers.

Dial a #.

M Intercom

Used to make internal calls and transfer calls to other T1 handsets registered to the base.

N Microphone



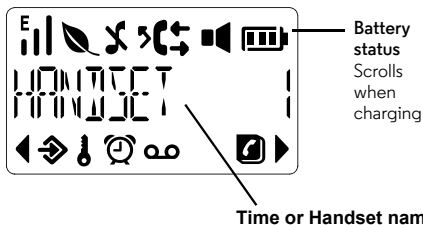











Handset LCD Display





Battery status
Scrolls
when
charging

Time or Handset name

In standby mode, press and hold  to switch handset idle screen between handset name or time.

-  Signal icon
-  ECO MODE is ON
-  ECO PLUS is ON
-  Handset ringer is off
-  Indicates a missed call
-  Steady when making an outgoing call
Flashes to indicate an incoming or internal call
-  Indicates an incoming call when viewing the calls list¹
-  Indicates an outgoing call when viewing the redial list¹
-  Hands-free is on
-  Menu is open
-  Keypad is locked
-  Alarm is set
-  Indicates new voicemail messages received
Off when there is no voicemail messages²
-  Phonebook is opened
-  Displayed number is longer than 12 digits.

The approximate power levels of your battery are indicated as follows:

-  Battery is fully charged
-  Battery is partially charged

 Battery is running low

 Flashes when battery is almost fully discharged

¹For this feature to work, you must subscribe to Caller ID Service from your network operator. A subscription fee may be payable.

²This feature is dependent on your Network Service provider supporting the service. A subscription fee may be payable.

Underside of the base

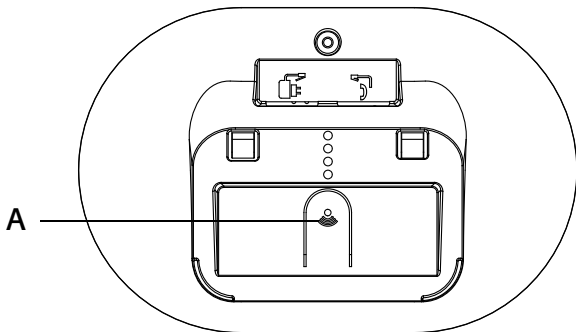

A Page

In standby mode, press to ring the handset(s).







Press and hold to enter registration mode when registering handsets.

Navigating the menus

Your T1 has an easy to use menu system.

Each menu has a list of options, which you can see on the menu map on the following page.

When the handset is switched on and in standby:

1. Press  to open the main menu.
2. Then use  or  buttons to scroll through the available options.
3. Press  to select an option. To return to the previous menu level, press . To exit the menu and return to standby, press .

NOTE

If no buttons are pressed for 30 seconds, the handset returns to standby automatically.

Menu map

PHONEBOOK

VIEW
ADD NEW
EDIT
DELETE¹
DELETE ALL¹

CLOCK/ALARM

DATE & TIME
SET ALARM

PERSONAL SET

HANDSET TONE
RING VOLUME
RING MELODY
KEY TONE
HANDSET NAME
AUTO ANSWER
LANGUAGE

ADVANCED SET

ECO MODE
ECO PLUS
AUTO PREFIX
RECALL TIME
DIAL MODE
CHANGE PIN
REGISTER
UNREGISTER
RESET

¹Only available if a phonebook entry is stored.

3. Using the phone

NOTE

The handset will automatically time the duration of all external calls. The call timer will display after the first 10 seconds of the call. When the call ends, the total duration of the talk time stays on the display for 3 seconds.

3.1 Switch the handset on / off



Press and hold  to switch the handset on or off.

3.2 Calls

3.2.1 Make a call

1. Press .
2. Dial the number.

3.2.2 Preparatory dialling

1. Dial the number first. If you make a mistake press  to delete the last digit.
2. Press  to dial.

3.2.3 End a call

Press , or place the handset back on the base or charger.

3.2.4 Receive a call



When you receive an external call, the phone rings and  icon flashes on the display.

1. Press  to answer the call.

NOTE



To answer calls by simply lifting the handset from the base, switch Auto answer on.

3.3 Adjust the earpiece volume

During a call, press  or  to increase or decrease the volume. There are 5 levels to choose from.

3.4 Mute

You can mute your handset so that you can talk to someone nearby without your caller hearing.





1. During a call, press . The display shows MUTE ON and your caller cannot hear you.
2. Press  again to resume your call.

3.5 Intercom

3.5.1 Make an internal call

If you have more than one handset registered to the base, you can make internal calls between two handsets.

The  icon flashes and the handset number that is being called is displayed.

1. If only 2 handsets are registered to the base, press  and the other handset rings automatically.
2. If more than 2 handsets are registered to the base press  and scroll  to the handset that is to be called then press .

3.5.2 Receive an internal call





When you receive an internal call, the  icon flashes and the handset number that is calling you is displayed.

1. Press  to answer the call.

3.5.3 Transfer a call

You can transfer an external call to another handset registered to the base.

During an external call:

1. If only 2 handsets are registered to the base, press  and the other handset rings automatically.
2. If more than 2 handsets are registered to the base press  and scroll  to the handset that is to be called then press .
3. When the other handset answers, press  to complete the transfer.







NOTE

If there is no answer from the other handset press  to return to the external caller. The external call resumes automatically after 60 seconds if there is no answer.

3.5.4 3-way conference call

You can hold a 3-way conference call between 2 internal callers and 1 external caller.



During a call with an external caller:



1. If only 2 handsets are registered to the base, press  and the other handset rings automatically.
2. If more than 2 handset are registered to the base press  and scroll  to the handset that is to join the call and press .
3. When the other handset answers, press and hold  to connect all three callers to begin the conference call.
4. Press  to end the call.

3.6 Hands-free

To talk to the caller without holding the handset and for other people in the room to listen to the conversation over the loudspeaker simply use the hands-free function.

3.6.1 Make a hands-free call

1. Press  twice, then dial the number. The  icon is displayed and the call can be heard over the handset loudspeaker.

2. Press  to switch the call between the earpiece and the loudspeaker.
3. Press  to end the call.



NOTE

During a hands-free call, press ▲ or ▼ to adjust the volume.

3.6.2 Answer a call hands-free

1. When the phone rings, press  twice to answer the call.



3.6.3 Switch to hands-free during a call.

1. During a call, press  to put the call on the loudspeaker.
2. To switch hands-free off and return the call to the earpiece, press  again.

3.7 Redial

The last 10 entries dialled are stored in the redial list.





3.7.1 View or dial an entry

1. Press  to open the Redial list.
2. Scroll ▲ or ▼ to the entry you want.
3. Press  to dial the displayed entry or press  to return to standby.

NOTE





If you have Caller ID and the caller's number exactly matches an entry stored in the phonebook, the name is displayed.

3.7.2 Copy a Redial list number to the phonebook







1. Press  to open the Redial list.
2. Scroll ▲ or ▼ to the entry you want.
3. Press , the display shows SAVE NUMBER.
4. Press  again. The display shows ENTER NAME.
5. Enter the name and press . The number is displayed.
6. Edit the number if necessary, then press . The number is stored.

See 'ENTERING NAMES' and 'WRITING TIPS' on page 19.

3.7.3 Delete an entry

1. Press  to open the Redial list.
2. Scroll ▲ or ▼ to the entry you want.
3. Press  if the phone number is stored in the phonebook the display shows DELETE, if not scroll ▼ to DELETE.
4. Press , the display shows CONFIRM?.
5. Press  to confirm or  to cancel.

3.7.4 Delete the entire Redial list



1. Press  to open the Redial list.
2. Press  and scroll  to DELETE ALL.
3. Press , the display shows CONFIRM?.
4. Press  to confirm or  to cancel.

3.8 Lock / unlock the keypad

You can lock the keypad so that it cannot be operated accidentally while carrying it around.

NOTE



When the keypad is locked, you can still answer incoming calls and operate the handset as normal during the call. When the call ends, the keypad lock comes on again.

1. Press and hold . KEYS LOCKED and  icon is displayed.
2. Press and hold  again to unlock the keypad.

3.9 Paging / Find handset

You can alert a handset user that they are wanted or locate a missing handset.

Paging calls cannot be answered by a handset.

1. Press  on the underside of the base. All handsets registered to the base will ring.
2. To stop the ringing, press  on the base again or press any button on the handset.

4. Phonebook

You can store up to 50 names and numbers in the phonebook. Names can be up to 12 characters long and numbers up to 24 digits.

4.1 Store a name and number

If the T1 is connected to a switchboard, you may need to enter a pause in a stored number. This gives the switchboard time to find an outside line.

A pause is normally stored after the switchboard access code (e.g. 9). When storing a number, press and hold **(#)** until the display shows P. You can then continue entering the phone number.

If you have subscribed to Caller ID Service and wish to display the name of your caller instead of the number, save the full telephone number including the area code to your phonebook.

You can store multiple entries with the same name. However, to prevent unnecessary duplicated entries, you can only store the number once.

1. Press **MENU OK**. The display shows PHONEBOOK.
2. Press **MENU OK**, scroll  to ADD NEW.
3. Press **MENU OK**. The display shows ENTER NAME.
4. Enter the name and press **MENU OK**. The display shows ENTER NUMBER.
5. Enter the number and press **MENU OK** to save.
6. The display shows ADD NEW.
7. Enter the next name and number entry that you wish to store in your phonebook or press **GO** to return to standby.

ENTERING NAMES

Use the keypad letters to enter names, e.g. to store TOM:

Press **8_{uv}** once to enter T.

Press **6_{mno}** three times to enter O.

Press **6_{mno}** once to enter M.

WRITING TIPS

Press **DEL** to delete the last character or digit.

Press **▲** or  to move between characters or digits.

Press **1_{space}** to insert a space.

Use **1_{dash}** twice to insert a dash.

4.2 View or dial an entry

1. Press . The icon is displayed.
2. Scroll or to the entry you want.
OR
Enter the first letter of the name to search alphabetically.
The first name that starts with this letter or the nearest letter in the alphabet will be displayed. Scroll or to the entry you want.
3. Press to dial or to return to standby.

NOTE

When the name is displayed, you can switch between the name and number by pressing .

4.3 Edit a name and number

1. Press . The display shows PHONEBOOK.
2. Press . Scroll to EDIT and press .
3. Scroll or to the entry you want to edit, or search alphabetically and press . The existing name is displayed.
4. Press to delete the name if required, then enter the new name and press . The existing number is displayed.
5. Press to delete the number if required, then enter the new number and press , the entry is saved.
6. Press to return to standby.

4.4 Delete an entry

1. Press . The display shows PHONEBOOK.
2. Press . Scroll to DELETE and press .
3. Scroll or to the entry you want to delete, or search alphabetically and press . The display shows CONFIRM?.
4. Press to confirm or to cancel.

4.5 Delete all entries

1. Press . The display shows PHONEBOOK.
2. Press . Scroll to DELETE ALL and press .
3. The display shows CONFIRM?.
4. Press to confirm or to cancel.

5. Caller ID and the Calls list

IMPORTANT

To use Caller ID, you must first subscribe to the service from your network provider. A subscription fee may be payable.

To ensure that the caller's name is displayed, make sure you have stored the full telephone number, including the area code in the phonebook.

If the number is unavailable, UNKNOWN will be displayed.

If the call is from an international number, INTERNATION. will be displayed.

If the call is from the operator, OPERATOR will be displayed.

If the call is from a payphone, PAYPHONE will be displayed.

If the call is from a ringback request, RINGBACK will be displayed.

5.1 Caller ID

If subscribed to Caller ID, the caller's number will be displayed (provided it is not withheld) prior to answering the call. The display can show the last 12 digits or characters of the phone numbers and names.









If the caller's name and number are stored in the phonebook and a number match is found, the caller's name will be displayed instead.

5.2 Calls list



The Calls list stores details of the last 20 received calls, including the phone number and date and time of the call.

The caller's details are stored in the Calls list whether or not the call has been answered. When the list is full, and a new call is received, the oldest entry will be deleted automatically.

5.2.1 View the Calls list









1. Press  to open the Calls list. If there are no calls in the list, the display shows LIST EMPTY.
2. Press  or  to scroll through the list.
 - If the call was answered,  icon is displayed as you scroll to the entry. If the call was unanswered,  icon is displayed as you scroll to the entry. When you reach the end of the list the display will show -----.
 - If the caller's number exactly matches an entry stored in the phonebook, the display will show the name. Keep pressing  to see the date and time of the call and the caller's number.
 - If the telephone number is longer than 12 digits,  icon is displayed. Press  to see the remaining digits.

5.2.2 Dial a number in the Calls list









1. Press  to open the Calls list.
2. Scroll  or  to the entry you want.

3. Press  to dial the displayed entry.







5.2.3 Copy a Calls list number to the phonebook

1. Press  to open the Calls list.
 2. Scroll  or  to the entry you want.
 3. Press  and scroll  to SAVE NUMBER.
 4. Press  again. The display shows ENTER NAME.
 5. Enter the name and press . The number is displayed.
 6. Edit the number if necessary, then press  to confirm.
- See 'ENTERING NAMES' and 'WRITING TIPS' on page 19.

5.2.4 Delete an entry







1. Press  to open the Calls list.
2. Scroll  or  to the entry you want and press .
3. Scroll  to DELETE and press .
4. The display shows CONFIRM?.
5. Press  to confirm or  to cancel.

5.2.5 Delete the entire Calls list

1. Press  to open the Calls list.
2. Press , scroll  to DELETE ALL and press .
3. The display shows CONFIRM?.
4. Press  to confirm or  to cancel.









6. Clock & alarm

6.1 Set the date and time

1. Press , scroll  to CLOCK/ALARM and press . The display shows DATE & TIME.
2. Press  to select.
3. Enter the date (e.g. 12-08-15 for 12th of August 2015) and press  to confirm.
4. Enter the time using the keypad (e.g. 06-30 for 6:30am) and press  to confirm.

6.2 Set the alarm

Each handset can have a different alarm setting.

1. Press , scroll  to CLOCK/ALARM and press .
2. Scroll  to SET ALARM and press .
3. Press  or  to select ON or OFF and press  to confirm.
4. If you select ON, enter the time using the keypad (e.g. 07-30 for 7:30) and press  to confirm.

6.3 Switch off alarm ring

When the alarm sounds, press any button to stop the ringing.

NOTE









Once the alarm is set to on, the  icon is displayed. When the alarm is ringing the  icon flashes.

7. Personal settings



7.1 Handset tones

7.1.1 Handset ringer volume

The handset ring volume can be set to different volume levels. Choose from 5 volume levels or Off.

1. Press , scroll  to PERSONAL SET and press .
2. The display shows HANDSET TONE, press .
3. The display shows RING VOLUME, press .
4. Press  or  to select the volume (1-5 or OFF).
5. Press  to confirm or  to return to the previous menu.











NOTE

When the phone is ringing, you can adjust the ringer volume by pressing  or .

7.1.2 Handset ringer melody











You can set different ringer melodies for your calls. Choose from 5 different ringer melodies.

You will hear a sample ring as you scroll to each ring melody.

1. Press , scroll  to PERSONAL SET and press .
2. The display shows HANDSET TONE, press .
3. Scroll  to RING MELODY and press .
4. Press  or  to select the ringer melody (1 - 5).
5. Press  to confirm or  to return to the previous menu.

7.1.3 Key beep

When you press a button on the handset keypad, you will hear a beep. You can switch these beeps on or off.





1. Press , scroll  to PERSONAL SET and press .
2. The display shows HANDSET TONE, press .
3. Scroll  to KEY TONE and press .
4. Press  or  to select ON or OFF.
5. Press  to confirm or  to return to the previous menu.

7.2 Handset name

If you are using more than one handset with your T1 base, you can set a personalized name for each handset to easily distinguish between them.

A name can be up to 10 characters long.









1. Press , scroll  to PERSONAL SET and press .

2. Scroll  to **HANDSET NAME** and press .
3. Enter the new handset name and press  to confirm.
Delete the current name by pressing .









See 'ENTERING NAMES' and 'WRITING TIPS' on page 19.

7.3 Auto answer

Your phone is set to answer calls by lifting the handset off the base or charger. You can switch this feature off so that calls can only be answered by pressing .

1. Press , scroll  to **PERSONAL SET** and press .
2. Scroll  to **AUTO ANSWER** and press .
3. Press  or  to select **ON** or **OFF**.
4. Press  to confirm or  to return to the previous menu.

7.5 Language









1. Press , scroll  to **PERSONAL SET** and press .
2. Scroll  to **LANGUAGE** and press .
3. Press  or  to select your preferred language.
4. Press  to confirm or  to return to the previous menu.

8. Base settings

8.1 ECO mode

Your T1 offers ECO mode function which reduces the transmitted power and energy consumption when switched on.

To switch Eco mode on:

1. Press , scroll  to ADVANCED SET and press .
2. The display shows ECO MODE and press .
3. Press  or  to select ON or OFF.
4. Press  to confirm or  to return to the previous menu.









NOTE

When ECO mode is set to ON, the handset range will be reduced.

8.2 ECO PLUS











When ECO PLUS is activated and the unit has been idle for 1 minute the transmitted power between the handset and the base will stop, an incoming call or pressing any key will activate the unit and it will revert back to the normal mode, until it has been idle again for 1 minute. This feature is set to OFF by default.

To switch ECO PLUS on:

1. Press , scroll  to ADVANCED SET and press .
2. Scroll  to ECO PLUS and press .
3. Press  or  to select ON or OFF.
4. Press  to confirm or  to return to the previous menu.

8.3 Auto Prefix









You can set the phone to detect a dialling number and replace it with another number. The number to be detected can be up to 5 digits long. It can be replaced with a number up to 10 digits long.

1. Press , scroll  to ADVANCED SET and press .
2. Scroll  to AUTO PREFIX, press .
3. DIGIT DETECT is displayed. Press .
4. Enter the number you want to be detected and press .
5. The display shows PREFIX and press .
6. Enter the number you want it replaced with.
7. Press  to confirm or  to return to standby.

8.4 Recall mode









This setting is useful to access certain network and PABX/switchboard services.

The default recall time is suitable for your country and network operator. It is unlikely that you should need to change this setting unless advised to do so.

1. Press , scroll  to ADVANCED SET and press .
2. Scroll  to RECALL TIME and press .
3. Press  or  to select SHORT, MEDIUM or LONG and press  to confirm.

8.5 Dial mode







Your T1 is set to tone dialling. You should only need to change this if connected to an older type of switchboard / PBX which requires pulse dialling.

1. Press , scroll  to ADVANCED SET and press .
2. Scroll  to DIAL MODE and press .
3. Press  or  to select TONE or PULSE and press  to confirm.

8.6 Change base PIN code

Some functions are protected by a 4 digit PIN code which must be entered if you want to change the settings. The default PIN is 0000. You can change this to your own preferred number.

When you enter a PIN, the digits are shown as ****.

1. Press , scroll  to ADVANCED SET and press .
2. Scroll  to CHANGE PIN and press .
3. The display shows NEW ----, enter the new 4 digit PIN code and press .
4. The display shows CONFIRM. Re-enter the new PIN and press  to confirm.

IMPORTANT

If you change the PIN code, please keep a record of the new number.

8.7 Registering an additional handset

You can register up to 4 handsets to your T1 base to extend your phone system without having to install extension sockets for each new phone.

If you have purchased a T1 multiple pack, all additional handsets come pre-registered to the base.

If you have purchased an additional handset separately, you must register it to your T1 base before it can be used.









NOTE

Handset batteries must be fully charged before you start to register. Hold your handset close to the base during the registration process.

On the base:

1. Press and hold  for 5 seconds. The base will remain in registration mode for 90 seconds.

On the handset:

1. If the handset is not register to a base press  and then enter the 4 digit PIN code (default = 0000) and press .
2. If the handset is already register to a base press , scroll  to ADVANCED SET and press .
3. Scroll  to REGISTER and press .
4. The display will ask for the PIN to be entered. Enter the 4 digit PIN code (default = 0000) and press . You will hear a beep if the registration is successful. The handset is automatically assigned an available handset number. Use this number when making internal calls.









NOTE

If registration is not successful the first time, please repeat the process again in case the base registration period ran out of time. If the base is not found after a few seconds, the handset returns to standby. Try registering again.

If there are already 4 handsets registered to the base, the registration will fail. You must de-register another handset before you can register a new one.

8.8 De-register a handset

Use one handset to de-register another. You cannot de-register the handset that you are using.

1. Press , scroll  to ADVANCED SET and press .
2. Scroll  to UNREGISTER and press .
3. Enter the 4 digit PIN code (default = 0000) and press .
4. Scroll  or  to select the handset number that you want to de-register and press . You will hear a confirmation beep and the display will return to the previous menu.

8.9 Restore default settings





You can restore your T1 to its default (original) settings.

All the handsets that are registered to the base will be retained.

IMPORTANT

Resetting your phone to its default settings will delete all entries in the Calls and Redial lists. Entries stored in the phonebook will be retained. Other handsets registered to the base will only return to the default time.

1. Press , scroll  to ADVANCED SET and press .

2. Scroll  to RESET and press .
3. The display shows RESET ?.
4. Press  to confirm or  to return to the previous menu. Your T1 will restart automatically.

NOTE

Once reset the handset will prompt you to reset the date and time, see page 23.

8.10 Default settings

Auto answer	OFF
Ringer melody	1
Ringer volume	3
Ear volume	2
Hands-free volume	3
Phonebook	Unchanged
Calls list	Empty
Redial list	Empty
PIN code	0000
Dial mode	Tone
Eco mode	OFF

9. Help

No dial tone

- Use only the telephone line cord supplied.
- Check that the telephone line cord is connected properly.
- Check that the mains power is connected properly and switched on.

No display

- Check that the batteries are inserted correctly and fully charged. Use only approved rechargeable batteries supplied.
- Check that the handset is switched on. Press and hold .
- Reset the base by removing the batteries and disconnecting the mains power. Wait for around 15 seconds before connecting it again. Allow up to one minute for the handset and base to synchronize.

Signal icon flashes

- Handset is out of range. Move closer to the base.
- Make sure that the handset is registered to the base.
- Check that the mains power is connected properly and switched on.

Keypad does not seem to work

- Check that the keypad lock is not on.

icon is not scrolling during charge

- Adjust the handset slightly on the base.
- Clean the charging contacts with a cloth moistened with alcohol.
- Check that the mains power is connected properly and switched on.
- The battery is full. When the handset is fully charged,  icon will appear steady on the display.

No Caller ID

- Check your subscription with your network operator.
- The caller may have withheld their number.
- The record cannot be found in your phonebook. Check that you have the correct name / number stored in your phonebook, with the full area code.

Cannot register a handset to the base

- You can register up to a maximum of 4 handsets to a T1 base. You must de-register a handset in order to register a new one.
- Check that you have entered the correct PIN code (default = 0000).
- Check that you are at least one metre away from other electrical equipment to avoid interference when registering.

Handset does not ring

- The handset ringer volume may be set to Off.

Base does not ring

- The base ringer volume may be set to Off.

Noise interference on my phone or on other electrical equipment nearby

- Place your T1 at least one metre away from electrical appliances or any metal obstructions to avoid any risk of interference.
-

10. General information

IMPORTANT

This equipment is not designed to make emergency telephone calls when the power fails. Alternative arrangements should be made for access to emergency services.

This product is intended for connection to analogue public switched telephone networks and private switchboards in Europe.

Important safety instructions

Follow these safety precautions when using your phone to reduce the risk of fire, electric shock, and injury to persons or property:

- Keep all slits and openings of the phone unblocked. Do not set the phone on a heating register or over a radiator. Ensure that proper ventilation is provided at the installation site.
- Do not use while wet or while standing in water.
- Do not use this product near water (for example, near a bath tub, kitchen sink, or swimming pool).
- Do not allow anything to rest on the power cord. Place the power cord so that it will not be walked on.
- Never insert objects of any kind into the product vents as that may result in fire or electric shock.
- Unplug this product from the wall outlet before cleaning. Do not use liquid cleaners or aerosol cleaners. Use a damp cloth for cleaning.
- Do not disassemble this product. If service or repair work is required, contact the customer service helpline found in this user's Guide.
- Do not overload wall outlets and extension cords.
- Avoid using during an electrical storm. Use a surge protector to protect the equipment.
- Do not use this phone to report a gas leak, especially if you are in the vicinity of the gas line.

IMPORTANT

To reduce the risk of fire, use only the supplied power adaptor.

Unplug this cordless phone immediately from an outlet if:

- The power cord or plug is damaged or frayed.
- Liquid has been spilled on the product.
- The product has been exposed to rain or water. Do not retrieve the handset or base until after you have unplugged the power and phone from the wall. Then retrieve the unit by the unplugged cords.
- The product has been dropped or the cabinet has been damaged.

- The product exhibits a distinct change in performance.

Installation Guidelines

- Read and understand all instructions and save them for future reference.
- Follow all warnings and instructions marked on the product.
- Do not install this product near a bath tub, sink, or shower.
- Operate this phone using only the power source that is indicated on the marking label. If you are unsure of the power supply to your home, consult with your dealer or local power company.
- Do not place this product on an unstable cart, stand, or table. This product may fall, causing serious damage to the product.
- Adjust only those controls that are covered by the operating instructions. Improper adjustment of other controls may result in damage and will often require extensive work to restore the product to normal operation.
- Clean this product with a soft, damp cloth. Do not use chemicals or cleaning agents to clean this phone.
- Use only the power supply that came with this unit. Using other power supplies may damage the unit.
- Because this phone operates on electricity, you should have at least one phone in your home that could operate without electricity in the case the power in your home goes out.
- To avoid interference to nearby appliances, do not place the base of the phone on or near a TV, microwave oven, or VCR.

Battery Safety Instructions

- Do not burn, disassemble, mutilate, or puncture the battery. The battery contains toxic materials that could be released, resulting in injury.

IMPORTANT

There is a risk of explosion if you replace the battery with an incorrect battery type. Use only the batteries that came with your phone or an authorized replacement recommended by the manufacturer.

- Keep batteries out of the reach of children.
- Remove batteries if storing over 30 days.
- Do not dispose of batteries in fire, which could result in explosion.
- The rechargeable batteries that power this product must be disposed of properly and may need to be recycled. Refer to your battery's label for battery type. Contact your local recycling center for proper disposal methods.

SAVE THESE INSTRUCTIONS

Cleaning

- Clean the handset and base (or charger) with a damp (not wet) cloth, or an anti-

static wipe.

- Never use household polish as this will damage the product. Never use a dry cloth as this may cause static shock.

Environmental

- Do not expose to direct sunlight.
- The handset may become warm when the batteries are being charged or during prolonged periods of use. This is normal. However, we recommend that to avoid damage, do not place the product on antique / veneered wood.
- Do not place your product on carpets or other surfaces which generate fibres, or place it in locations preventing the free flow of air over its surfaces.
- Do not submerge any part of your product in water and do not use it in damp or humid conditions, such as bathrooms.
- Do not expose your product to fire, explosives or other hazardous conditions.
- There is a slight chance that your phone could be damaged by an electrical storm. We recommend that you unplug the power and telephone line cord during an electrical storm.

Product disposal instructions

Product disposal instructions for residential users

When you have no further use for it, please remove any batteries and dispose of them and the product according to your local authority's recycling processes. For more information, please contact your local authority or the retailer where the product was purchased.

Product disposal instructions for business users

Business users should contact their suppliers and check the terms and conditions of the purchase contract and ensure that this product is not mixed with other commercial waste for disposal.

Consumer Products and Accessories Warranty

Thank you for purchasing this Motorola branded product manufactured under license by Suncorp Technologies Limited, 2/F, Shui On Centre, 6-8 Harbour Road, Hong Kong. ("SUNCORP")

What Does this Warranty Cover?

Subject to the exclusions contained below, SUNCORP warrants that this Motorola branded product ("Product") or certified accessory ("Accessory") sold for use with this product that it manufactured to be free from defects in materials and workmanship under normal consumer usage for the period outlined below. This Limited Warranty is your exclusive warranty and is not transferable.

Who is covered?

This warranty extends only to the first consumer purchaser, and is not transferable.

What will SUNCORP do?

SUNCORP or its authorized distributor at its option and within a commercially reasonable time, will at no charge repair or replace any Products or Accessories that do not conform to this limited warranty. We may use functionally equivalent reconditioned / refurbished / pre-owned or new Products, Accessories or parts.

What Other Limitations Are There?

ANY IMPLIED WARRANTIES, INCLUDING WITHOUT LIMITATION THE IMPLIED WARRANTIES OF MERCHANTABILITY AND FITNESS FOR A PARTICULAR PURPOSE, SHALL BE LIMITED TO THE DURATION OF THIS LIMITED WARRANTY, OTHERWISE THE REPAIR OR REPLACEMENT PROVIDED UNDER THIS EXPRESS LIMITED WARRANTY IS THE EXCLUSIVE REMEDY OF THE CONSUMER, AND IS PROVIDED IN LIEU OF ALL OTHER WARRANTIES, EXPRESS OF IMPLIED. IN NO EVENT SHALL MOTOROLA OR SUNCORP BE LIABLE, WHETHER IN CONTRACT OR TORT (INCLUDING NEGLIGENCE) FOR DAMAGES IN EXCESS OF THE PURCHASE PRICE OF THE PRODUCT OR ACCESSORY, OR FOR ANY INDIRECT, INCIDENTAL, SPECIAL OR CONSEQUENTIAL DAMAGES OF ANY KIND, OR LOSS OF REVENUE OR PROFITS, LOSS OF BUSINESS, LOSS OF INFORMATION OR OTHER FINANCIAL LOSS ARISING OUT OF OR IN CONNECTION WITH THE ABILITY OR INABILITY TO USE THE PRODUCTS OR ACCESSORIES TO THE FULL EXTENT THESE DAMAGES MAY BE DISCLAIMED BY LAW.

Some jurisdictions do not allow the limitation or exclusion of incidental or consequential damages, or limitation on the length of an implied warranty, so the above limitations or exclusions may not apply to you. This warranty gives you specific legal rights, and you may also have other rights that vary from one jurisdiction to another.

Products Covered	Length of Coverage
Consumer Products	Two (2) years from the date of the products original purchase by the first consumer purchaser of the product.
Consumer Accessories (battery, power supply(s) and line cords)	Ninety (90) days from the date of the accessories original purchase by the first consumer purchaser of the product.
Consumer Products and Accessories that are Repaired or Replaced	The balance of the original warranty or for ninety (90) days from the date returned to the consumer, whichever is longer.

Exclusions

Normal Wear and Tear. Periodic maintenance, repair and replacement of parts due to normal wear and tear are excluded from coverage.

Batteries. Only batteries whose fully charged capacity falls below 80% of their rated capacity and batteries that leak are covered by this limited warranty.

Abuse & Misuse. Defects or damage that result from: (a) improper operation, storage, misuse or abuse, accident or neglect, such as physical damage (cracks, scratches, etc.) to the surface of the product resulting from misuse; (b) contact with liquid, water, rain,

extreme humidity or heavy perspiration, sand, dirt or the like, extreme heat, or food; (c) use of the Products or Accessories for commercial purposes or subjecting the Product or Accessory to abnormal usage or conditions; or (d) other acts which are not the fault of Motorola or SUNCORP are excluded from coverage.

Use of Non-Motorola branded Products and Accessories. Defects or damage that result from the use of Non-Motorola branded or certified Products or Accessories or other peripheral equipment are excluded from coverage.

Unauthorized Service or Modification. Defects or damages resulting from service, testing, adjustment, installation, maintenance, alteration, or modification in any way by someone other than Motorola, SUNCORP or its authorized service centers, are excluded from coverage.

Altered Products. Products or Accessories with (a) serial numbers or date tags that have been removed, altered or obliterated; (b) broken seals or that show evidence of tampering; (c) mismatched board serial numbers; or (d) nonconforming or non-Motorola branded housings, or parts, are excluded from coverage.

Communication Services. Defects, damages, or the failure of Products or Accessories due to any communication service or signal you may subscribe to or use with the Products or Accessories is excluded from coverage.

How to Obtain Warranty Service or Other Information?

To obtain service or information, please call: XXXX XXXXXX.

You will receive instructions on how to ship the Products or Accessories at your expense and risk, to a SUNCORP Authorized Repair Center.

To obtain service, you must include: (a) the Product or Accessory; (b) the original proof of purchase (receipt) which includes the date, place and seller of the Product; (c) if a warranty card was included in your box, a completed warranty card showing the serial number of the Product; (d) a written description of the problem; and, most importantly; (e) your address and telephone number.

Technical Information

How many telephones can I have? All items of telephone equipment have a Ringer Equivalence Number (REN), which is used to calculate the number of items which may be connected to any one telephone line. Your T1 has a REN of 1. A total REN of 4 is allowed. If the total REN of 4 is exceeded, the telephones may not ring. With different telephone types, there is no guarantee of ringing, even when the REN is less than 4.

Any additional handsets and chargers that you register have a REN of 0.

Connecting to a switchboard

This product is intended for use within Europe for connection to the public telephone network.

Recall

You may need to use the recall function if you are connected to a switch. Contact your PABX supplier for further information.

<This page has been intentionally left blank>

<This page has been intentionally left blank>

Declaration of Conformity (DoC)

Suncorp declares that the following products:

Brandname: Motorola
Type: T101, T102, T103 and T104
Descriptions: DECT phone without telephone answering machine (T10x) and their multi-handset versions.

to which this declaration related is in conformity with the essential requirements of the following directives of the Council of the European Communities:

- R&TTE Directive (1999/5/EC)
- Ecodesign Directive (2009/125/EC)

The products are compliant with the following standards:

Safety: EN60950-1:2006+A11:2009+A1:2010+A12:2011+A2:2013

EMC: EN301489-1 v1.9.2 and EN301489-6 v1.3.1

RF Spectrum: EN301406 v2.1.1

Ecodesign: EC No 278/2009, 6 April 2009

For and on behalf of Suncorp Technologies Limited,

CW Cheung
2015.03.30 16:58:07 +08'00'

Signature:

Printed name & Position: CW Cheung – Chief Technical Officer

Date: March 30, 2015

Place: 2/F, Shui On Centre, 6-8 Harbour Road, Hong Kong

Manufactured, distributed or sold by Suncorp Technologies Ltd., official licensee for this product. MOTOROLA and the Stylized M Logo are trademarks or registered trademarks of Motorola Trademark Holdings, LLC. and are used under license. All other trademarks are the property of their respective owners. © 2015 Motorola Mobility LLC. All rights reserved.

Version 1 (EU)

