



motorola

Corded Telephone



Motorola CT1



Welcome...

to your new Motorola CT1 Corded Telephone!

- 3 direct dial memory keys for easy one-touch dialling.
- 10 two-touch memory keys for easy dialling.
- Redial to easily dial the last number called.
- Tone dialling.
- Mute your caller so you can have a private conversation with someone nearby.
- LED indicator shows when mute is activated.
- Ringer volume switch to change the volume between high and low.
- Recall for network functions.
- Wall mountable for space efficiency.

Need help?

If you have any problems setting up or using your CT1, please contact Customer Services on xxxxxxxxxxxx.

Alternatively, you may find the answer in the 'Help' section at the back of this guide.

This user guide provides you with all the information you need to get the most from your phone.

To set up your phone, follow the simple instructions in 'Getting Started'.

IMPORTANT

Only use the telephone line cord supplied.

Got everything?

- Corded handset and curly cord
- Corded base
- Telephone line cord
- User guide



ECOMOTO: a convergence of efforts by marketing, design, research, engineering and supply chain management that leads to better products for everyone. A holistic view that focuses on both social and environmental responsibility.

A passion and a shared point of view.

The right thing to do.

- Meets and/or exceeds EMEA environmental regulatory requirements.
- Eco friendly packaging with a minimum 20% post consumer recycled content.
- Phone housing is built with a minimum of 25% post consumer recycled content plastic.

1.	Getting started	5
2.	Getting to know your phone	6
3.	Using the phone	9
3.1	Calls	9
3.1.1	Make a call	9
3.1.2	End a call	9
3.1.3	Receive a call	9
3.2	Mute	9
3.3	Redial	9
4.	Memory	10
4.1	Store a direct dial number	10
4.2	Dial a direct dial number	10
4.3	Store a two-touch number	10
4.4	Dial a two-touch number	10
5.	Recall mode	11
6.	Help	12
7.	General information	13
8.	Wall mounting	17

1. Getting started

IMPORTANT

Do not place your CT1 in the bathroom or other humid areas.



Location

You need to place your CT1 base within 2 metres of the telephone wall socket so that the cable will reach. The socket-outlet shall be installed near the equipment and shall be easily accessible.

If you are wall mounting your phone please refer to the wall mount template on page 17.

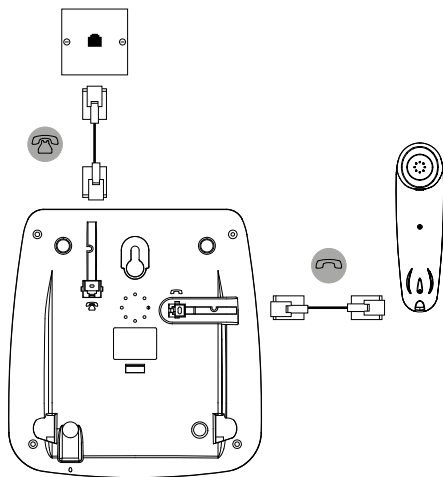
Connecting the handset and base



1. Plug one end of the handset curly cord into the socket marked  on the underside of the base and the other end into the socket at the bottom of the handset.
2. Plug the telephone line cord into the socket marked .

2. Getting to know your phone

Overview of the base

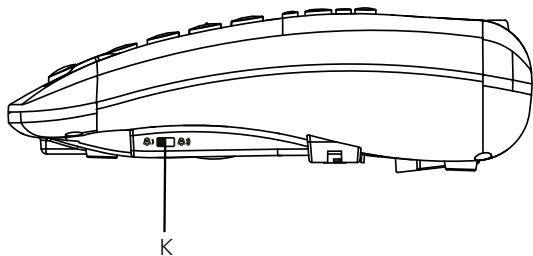
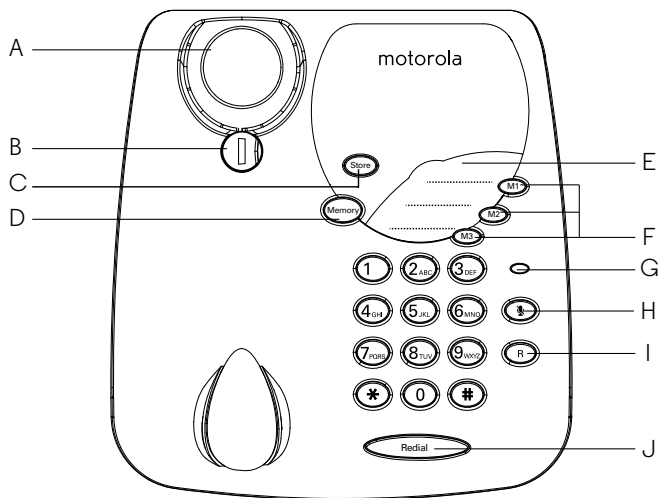

- A Hook switch**
Hangs up a call when pressed or when you replace the handset.
- B Handset hook**
Rotate to secure the handset in wall mount mode.
- C Store**
For storing direct dial or two-touch memory numbers.
- D Memory**
For dialling numbers from the two-touch memory.
- E Memory label**
Make a record of your 3 direct dial numbers; remove covering plastic before recording the number.
- F Direct dial (M1, M2, M3)**
Press to store or dial a direct dial number.
- G LED**
Lights up when mute is activated.
- H Mute**
Speak to someone nearby without your caller hearing the conversation.
- I R**
Recall used with switchboards / PABX.
- J Redial**
Press to redial the last number called.
- K Ringer switch**
Switch the ringer volume from high (🔊) to low (🔇).

Overview of your handset

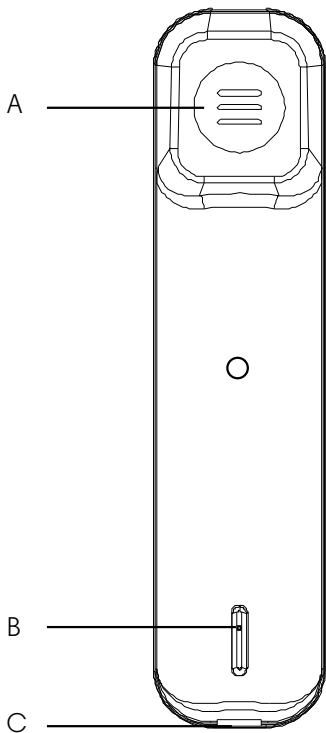

A Earpiece

To listen to your caller.

B Microphone

To speak to your caller.

C Curly cord socket

Where you plug in your curly cord.

3. Using the phone

3.1 Calls

3.1.1 Make a call

Lift the handset, when you hear the dial tone, dial the number.

3.1.2 End a call



Place the handset back on the base.

3.1.3 Receive a call

Lift the handset to answer the call.

3.2 Mute

You can mute your handset so that you can talk to someone nearby without your caller hearing.

1. During a call, press . The LED will light up.
2. Press  again to resume your call. The LED will turn off.

3.3 Redial

The last entry dialled is stored in the phone; the number can be up to 48 digits long.



To redial the last entry called, pick up the handset and press .

4. Memory

You can store one of your most frequently used telephone numbers in each of the direct dial memories (M1, M2 or M3), the number can be up to 20 digits long.

You can store a further ten telephone numbers in the two touch memory; the numbers can be up to 20 digits long.

4.1 Store a direct dial number

1. Lift the handset and press  key.
2. Dial the number to be stored.
3. Press  key .
4. Press one of the memory keys M1, M2 or M3.
5. Place the handset back on the base.



NOTE

Remember to record your direct dial memory names on the label provided.

4.2 Dial a direct dial number

1. Lift the handset.
2. Press one of the memory keys M1, M2 or M3.
3. The memory number will be dialled out automatically.

4.3 Store a two-touch number

1. Lift the handset and press  key.
2. Dial the number to be stored.
3. Press  key.
4. Press one of the keypad buttons 0-9.
5. Place the handset back on the base.

NOTE

Remember to make a note of which phone numbers are store under which keypad number.

4.4 Dial a two-touch number

1. Lift the handset.
2. Press  key.
3. Press one of the keypad buttons 0-9.
4. The memory number will be dialled out.

5. *Recall mode*

Recall is useful to access certain network services and PABX /switchboard services.

For more information about network services contact your network operator.

The recall mode preset in the CT1 is suitable for your country network.

6. Help

No dial tone

- Use only the telephone line cord supplied.
- Check that the telephone line cord is connected properly.

Storing numbers

- Once you have stored a number there is no confirmation tone, just hang up the handset.
- A number cannot be deleted once store, you can overwrite it with a new number.

Cannot hear your caller

- Make sure mute is not activated. If the LED is lit press  to turn mute off.

7. General information

IMPORTANT

This product is intended for connection to analogue public switched telephone networks and private switchboards in Europe.

Important safety instructions

Follow these safety precautions when using your phone to reduce the risk of fire, electric shock, and injury to persons or property:

- Do not set the phone on a heating register or over a radiator. Ensure that proper ventilation is provided at the installation site.
- Do not use while wet or while standing in water.
- Do not use this product near water (for example, near a bath tub, kitchen sink, or swimming pool).
- Do not disassemble this product. If service or repair work is required, contact the customer service helpline found in this User Guide.
- Avoid using during an electrical storm. Use a surge protector to protect the equipment.

Installation Guidelines

- Read and understand all instructions and save them for future reference.
- Follow all warnings and instructions marked on the product.
- Do not install this product near a bath tub, sink, or shower.
- Do not place this product on an unstable cart, stand, or table. This product may fall, causing serious damage to the product.
- Adjust only those controls that are covered by the operating instructions. Improper adjustment of other controls may result in damage and will often require extensive work to restore the product to normal operation.

Cleaning

- Clean the handset and base with a damp (not wet) cloth, or an anti-static wipe.
- Never use household polish as this will damage the product. Never use a dry cloth as this may cause static shock.

Environmental

- Do not expose to direct sunlight.
- Do not place your product on carpets or other surfaces which generate fibres, or place it in locations preventing the free flow of air over its surfaces.
- Do not submerge any part of your product in water and do not use it in damp or humid conditions, such as bathrooms.
- Do not expose your product to fire, explosives or other hazardous conditions.

- There is a slight chance that your phone could be damaged by an electrical storm. We recommend that you unplug the telephone line cord during an electrical storm.

Product disposal instructions

Product disposal instructions for residential users

When you have no further use for it, please dispose the product according to your local authority's recycling processes. For more information, please contact your local authority or the Retailer where the product was purchased.

Product disposal instructions for business users

Business users should contact their suppliers and check the terms and conditions of the purchase contract and ensure that this product is not mixed with other commercial waste for disposal.

Consumer Products and Accessories Warranty

Thank you for purchasing this Motorola branded product manufactured under license by Suncorp Technologies Limited, 2/F, Shui On Centre, 6-8 Harbour Road, Hong Kong. ("SUNCORP")

What Does this Warranty Cover?

Subject to the exclusions contained below, SUNCORP warrants that this Motorola branded product ("Product") or certified accessory ("Accessory") sold for use with this product that it manufactured to be free from defects in materials and workmanship under normal consumer usage for the period outlined below. This Limited Warranty is your exclusive warranty and is not transferable.

Who is covered?

This warranty extends only to the first consumer purchaser, and is not transferable.

What will SUNCORP do?

SUNCORP or its authorized distributor at its option and within a commercially reasonable time, will at no charge repair or replace any Products or Accessories that do not conform to this limited warranty. We may use functionally equivalent reconditioned / refurbished / pre-owned or new Products, Accessories or parts.

What Other Limitations Are There?

ANY IMPLIED WARRANTIES, INCLUDING WITHOUT LIMITATION THE IMPLIED WARRANTIES OF MERCHANTABILITY AND FITNESS FOR A PARTICULAR PURPOSE, SHALL BE LIMITED TO THE DURATION OF THIS LIMITED WARRANTY, OTHERWISE THE REPAIR OR REPLACEMENT PROVIDED UNDER THIS EXPRESS LIMITED WARRANTY IS THE EXCLUSIVE REMEDY OF THE CONSUMER, AND IS PROVIDED IN LIEU OF ALL OTHER WARRANTIES, EXPRESS OF IMPLIED. IN NO EVENT SHALL MOTOROLA OR SUNCORP BE LIABLE, WHETHER IN CONTRACT OR TORT (INCLUDING NEGLIGENCE) FOR DAMAGES IN EXCESS OF THE PURCHASE PRICE OF THE PRODUCT OR ACCESSORY, OR FOR ANY INDIRECT, INCIDENTAL, SPECIAL OR CONSEQUENTIAL DAMAGES OF ANY KIND, OR LOSS OF INFORMATION OR OTHER FINANCIAL LOSS ARISING OUT OF OR IN CONNECTION WITH THE ABILITY OR INABILITY TO USE THE PRODUCTS OR ACCESSORIES TO THE FULL EXTENT

THESE DAMAGES MAY BE DISCLAIMED BY LAW.

Some jurisdictions do not allow the limitation or exclusion of incidental or consequential damages, or limitation on the length of an implied warranty, so the above limitations or exclusions may not apply to you. This warranty gives you specific legal rights, and you may also have other rights that vary from one jurisdiction to another.

Products Covered	Length of Coverage
Consumer Products	Two (2) years from the date of the products original purchase by the first consumer purchaser of the product.
Consumer Accessories (line cord)	Ninety (90) days from the date of the accessories original purchase by the first consumer purchaser of the product.
Consumer Products and Accessories that are Repaired or Replaced	The balance of the original warranty or for ninety (90) days from the date returned to the consumer, whichever is longer.

Exclusions

Normal Wear and Tear. Periodic maintenance, repair and replacement of parts due to normal wear and tear are excluded from coverage.

Abuse & Misuse. Defects or damage that result from: (a) improper operation, storage, misuse or abuse, accident or neglect, such as physical damage (cracks, scratches, etc.) to the surface of the product resulting from misuse; (b) contact with liquid, water, rain, extreme humidity or heavy perspiration, sand, dirt or the like, extreme heat, or food; (c) use of the Products or Accessories for commercial purposes or subjecting the Product or Accessory to abnormal usage or conditions; or (d) other acts which are not the fault of Motorola or SUNCORP, are excluded from coverage.

Use of Non-Motorola branded Products and Accessories. Defects or damage that result from the use of Non-Motorola branded or certified Products or Accessories or other peripheral equipment are excluded from coverage.

Unauthorized Service or Modification. Defects or damages resulting from service, testing, adjustment, installation, maintenance, alteration, or modification in any way by someone other than Motorola, SUNCORP or its authorized service centres, are excluded from coverage.

Altered Products. Products or Accessories with (a) serial numbers or date tags that have been removed, altered or obliterated; (b) broken seals or that show evidence of tampering; (c) mismatched board serial numbers; or (d) nonconforming or non-Motorola branded housings, or parts, are excluded from coverage.

Communication Services. Defects, damages, or the failure of Products or Accessories due to any communication service or signal you may subscribe to or use with the Products or Accessories is excluded from coverage.

How to Obtain Warranty Service or Other Information?

To obtain service or information, please call: XXXXXXXXXXXX.

You will receive instructions on how to ship the Products or Accessories at your expense and risk, to a SUNCORP Authorized Repair Centre. To obtain service, you must include: (a) the Product or Accessory; (b) the original proof of purchase (receipt) which includes the date, place and seller of the Product; (c) if a warranty card was included in your box, a completed warranty card showing the serial number of the Product; (d) a written description of the problem; and, most importantly; (e) your address and telephone number.

Technical Information

How many telephones can I have?

All items of telephone equipment have a Ringer Equivalence Number (REN), which is used to calculate the number of items which may be connected to any one telephone line. Your CT1 has a REN of 1. A total REN of 4 is allowed. If the total REN of 4 is exceeded, the telephones may not ring. With different telephone types, there is no guarantee of ringing, even when the REN is less than 4.

Connecting to a switchboard

This product is intended for use within Europe for connection to the public telephone network.

Recall

You may need to use the recall function if you are connected to a switchboard. Contact your PABX supplier for further information.

8. Wall mounting

IMPORTANT

Before you wall-mount your CTI, check that you are not drilling into any hidden wiring or pipes. Before you drill, make sure the telephone line cable will reach the socket.

1. Drill two holes in the wall 9.2cm apart vertically using an 8mm drill bit.

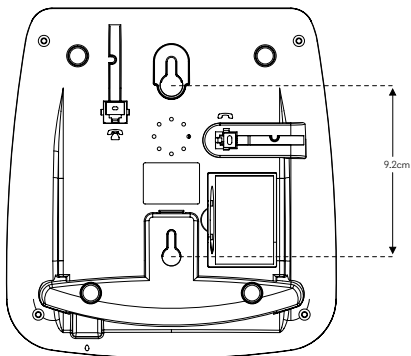

<This page has intentionally been left blank>

Declaration of Conformity (DoC)

Suncorp declares that the following products:

Brandname: Motorola
Type: CT1
Descriptions: Corded telephone

to which this declaration related is in conformity with the essential requirements of the following directives of the Council of the European Communities:

- Low voltage Directive (2006/95/EC)
- EMC Directive (2004/108/EC)
- R&TTE Directive (1999/5/EC)

The products are compliant with the following standards:

Safety: EN60950-1:A12:2011
EMC: EN55022:2010
EN55024:2010

For and on behalf of Suncorp Technologies Limited,

CW Cheung
2014.04.09
11:44:08
+08'00'

Signature:



Printed name & Position: CW Cheung – Chief Technical Officer

Date: April 9, 2014

Place: 2/F, Shui On Centre, 6-8 Harbour Road, Hong Kong

Manufactured, distributed or sold by Suncorp Technologies Ltd., official licensee for this product. MOTOROLA and the Stylized M Logo are trademarks or registered trademarks of Motorola Trademark Holdings, LLC. and are used under license. All other trademarks are the property of their respective owners. © 2014 Motorola Mobility LLC. All rights reserved.

Version 5 (EU)

